



Ventilación y Extracción  
**CONDUCTOS RÍGIDOS PARA LA VENTILACIÓN Y EXTRACCIÓN**

NORMA UNE-EN 61591

		<i>Descripción</i>	<i>Referencia</i>	<i>Euros</i>	
		<b>Tubo Plano Rectangular</b> 75x150/ L=1500	TPH120	19,68 €	
		<b>Tubo Redondo</b> Ø 120/ L=1500	TRH120	18,42 €	
		<b>Empalme Rectangular</b>	ERH120	2,55 €	
		<b>Empalme Redondo</b>	ERR120	2,26 €	
		<b>Empalme Mixto</b>	EMH120	5,62 €	
		<b>Codo Mixto 90º</b>	CMH90	5,09 €	
		<b>Codo Vertical 90º</b>	CVH90	5,09 €	
		<b>Codo Horizontal 90º</b>	CHH90	5,62 €	
		<b>Codo Horizontal 45º</b>	CHH45	5,62 €	
		<b>Remate Pared Rectangular</b>	RPR75	1,74 €	
		<b>Remate Pared Redondo</b>	RPR120	1,94 €	
		<b>Ventanilla Salida Exterior Rectangular</b>	VER75	5,33 €	
		<b>Ventanilla Salida Exterior Redonda</b>	VER120	5,33 €	
		<b>Abrazadera Rectangular</b>	AR75	2,26 €	
		<b>Abrazadera Redonda</b>	AR120	2,55 €	
		<b>Aro Reducctor</b>	AR102	2,26 €	
		<b>Codo Redondo 90º</b>	CR90	5,37 €	
		<b>Rejilla Metálica</b>	150x150	RM150	3,15 €
			200x200	RM200	5,01 €



TUBO HELICOIDAL GALVANIZADO

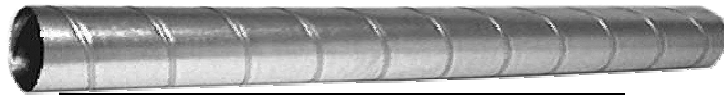

Referencia	Diámetro	Longitud	Espesor	Euros/metro
THG805	80	3 mts	0,5	6,27 €
THG105	100	3 mts	0,5	6,37 €
THG125	125	3 mts	0,5	7,97 €
THG135	135	3 mts	0,5	8,76 €
THG155	150	3 mts	0,5	9,57 €
THG175	175	3 mts	0,5	10,96 €
THG205	200	3 mts	0,5	12,76 €
THG225	225	3 mts	0,5	14,16 €
THG255	250	3 mts	0,5	15,75 €
THG306	300	3 mts	0,6	22,92 €

ACCESORIOS

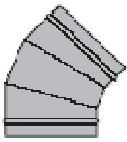
Codo 45°	Código	Diámetro	Precio/ UD
	CHG804	80-45°	11,66 €
	CHG104	100-45°	12,22 €
	CHG124	125-45°	14,12 €
	CHG134	135-45°	14,50 €
	CHG154	150-45°	16,38 €
	CHG174	175-45°	17,13 €
	CHG204	200-45°	20,31 €
	CHG224	225-45°	24,59 €
	CHG254	250-45°	27,30 €
	CHG304	300-45°	35,84 €

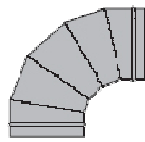
Codo 90°	Código	Diámetro	Precio/ UD
	CHG809	80-90°	13,91 €
	CHG109	100-90°	14,50 €
	CHG129	125-90°	15,42 €
	CHG139	135-90°	16,17 €
	CHG159	150-90°	18,26 €
	CHG179	175-90°	21,26 €
	CHG209	200-90°	28,21 €
	CHG229	225-90°	32,34 €
	CHG259	250-90°	35,62 €
	CHG309	300-90°	49,77 €

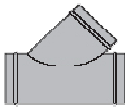
Derivación 45°	Código	Diámetro	Precio/ UD
	DHS804	80-45°	14,08 €
	DHS104	100-45°	15,25 €
	DHS124	125-45°	17,98 €
	DHS134	135-45°	21,70 €
	DHS154	150-45°	24,05 €
	DHS174	175-45°	27,19 €
	DHS204	200-45°	31,68 €
	DHS224	225-45°	38,53 €
	DHS254	250-45°	43,21 €
	DHS304	300-45°	60,04 €

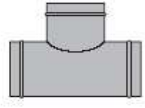
Derivación 90°	Código	Diámetro	Precio/ UD
	DHS808	80-90°	11,88 €
	DHS108	100-90°	12,65 €
	DHS128	125-90°	14,97 €
	DHS138	135-90°	15,53 €
	DHS158	150-90°	19,56 €
	DHS178	175-90°	21,68 €
	DHS208	200-90°	24,56 €
	DHS228	225-90°	28,77 €
	DHS258	250-90°	33,19 €
	DHS308	300-90°	42,19 €

MANGUITO	Código	Diámetro	Precio/ UD
	MHG80	80	2,54 €
	MHG100	100	2,54 €
	MHG125	125	2,75 €
	MHG135	135	2,75 €
	MHG150	150	3,33 €
	MHG175	175	3,72 €
	MHG200	200	4,10 €
	MHG225	225	4,49 €
	MHG250	250	4,89 €
	MHG300	300	6,05 €

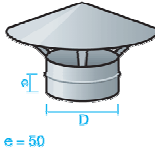
SOMBRETE	Código	Diámetro	Precio/ UD
	SNG125	80	14,72 €
	SNG100	100	15,89 €
	SNG125	125	17,83 €
	SNG135	135	18,20 €
	SNG150	150	19,18 €
	SNG175	175	21,70 €
	SNG200	200	22,85 €
	SNG225	225	25,18 €
	SNG250	250	27,11 €
	SNG300	300	31,97 €

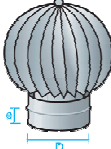
SOMBRETE GIRATORIO Galvanizado	Código	Diámetro	Precio/ UD
	SAG125	125	113,13 €
	SAG150	150	115,35 €
	SAG175	175	134,75 €
	SAG200	200	138,18 €
	SAG250	250	148,18 €
	SAG300	300	160,61 €
	SAG355	355	234,75 €
	SAG400	400	326,87 €

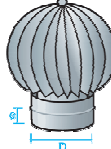
SOMBRETE GIRATORIO INOX	Código	Diámetro	Precio/ UD
	SAI125	125	195,76 €
	SAI150	150	207,27 €
	SAI175	175	217,78 €
	SAI200	200	231,31 €
	SAI250	250	250,30 €
	SAI300	300	301,41 €
	SAI355	355	476,97 €
	SAI400	400	644,04 €

OTROS DIAMETROS Y REFERENCIAS CONSULTAR

CINTA DE ALUMINIO	Código	Mts	Precio/ UD
	CDA505	50	11,72 €

Tubería Flexible de Aluminio (Extracción de Humos)



Código	Diámetro	Euros/ Mts
TFA100	100	3,05 €
TFA110	110	3,27 €
TFA120	120	3,50 €
TFA125	125	3,97 €







ACCESORIOS CON JUNTA DE GOMA

**ACCESORIOS**

<b>Codo 45°</b>		<b>Código</b>	<b>Diámetro</b>	<b>Precio/ UD</b>
 <b>ESTAMPADO</b>	<b>CEG804</b>	80-45°	12,64 €	
	<b>CEG104</b>	100-45°	13,11 €	
	<b>CEG124</b>	125-45°	17,90 €	
	<b>CEG154</b>	150-45°	21,33 €	
	<b>CEG204</b>	200-45°	32,30 €	
 <b>ENGATILLADO</b>	<b>CJG204</b>	200-45°	36,54 €	
	<b>CJG254</b>	250-45°	47,21 €	
	<b>CJG304</b>	300-45°	63,36 €	
	<b>CJG354</b>	355-45°	73,70 €	
	<b>CJG404</b>	400-45°	83,63 €	
	<b>CJG454</b>	450-45°	91,98 €	
	<b>CJG504</b>	500-45°	109,19 €	

<b>Codo 90°</b>		<b>Código</b>	<b>Diámetro</b>	<b>Precio/ UD</b>
 <b>ESTAMPADO</b>	<b>CEG809</b>	80-90°	12,98 €	
	<b>CEG109</b>	100-90°	14,76 €	
	<b>CEG129</b>	125-90°	18,76 €	
	<b>CEG159</b>	150-90°	23,82 €	
	<b>CEG209</b>	200-90°	39,38 €	
 <b>ENGATILLADO</b>	<b>CJG209</b>	200-90°	42,22 €	
	<b>CJG259</b>	250-90°	52,36 €	
	<b>CJG309</b>	300-90°	73,51 €	
	<b>CJG359</b>	350-90°	84,00 €	
	<b>CJG409</b>	400-90°	100,89 €	
	<b>CJG459</b>	450-90°	115,07 €	
	<b>CJG509</b>	500-90°	142,22 €	

<b>Derivación 45°</b>		<b>Código</b>	<b>Diámetro</b>	<b>Precio/ UD</b>
	<b>DJG804</b>	80-45°	21,33 €	
	<b>DJG104</b>	100-45°	24,04 €	
	<b>DJG124</b>	125-45°	28,62 €	
	<b>DJG154</b>	150-45°	36,44 €	
	<b>DJG204</b>	200-45°	50,80 €	
	<b>DJG224</b>	225-45°	59,60 €	
	<b>DJG254</b>	250-45°	66,40 €	
	<b>DJG304</b>	300-45°	92,98 €	

<b>Derivación 90°</b>		<b>Código</b>	<b>Diámetro</b>	<b>Precio/ UD</b>
	<b>DJG809</b>	80-90°	18,71 €	
	<b>DJG109</b>	100-90°	20,98 €	
	<b>DJG129</b>	125-90°	25,02 €	
	<b>DJG159</b>	150-90°	31,11 €	
	<b>DJG209</b>	200-90°	42,63 €	
	<b>DJG229</b>	225-90°	48,00 €	
	<b>DJG259</b>	250-90°	54,58 €	
	<b>DJG309</b>	300-90°	71,87 €	

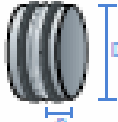
<b>MANGUITO</b>	<b>Código</b>	<b>Diámetro</b>	<b>Precio/ UD</b>
	<b>MJG80</b>	80	6,13 €
	<b>MJG100</b>	100	7,02 €
	<b>MJG125</b>	125	8,13 €
	<b>MJG150</b>	150	9,29 €
	<b>MJG200</b>	200	13,78 €
	<b>MJG225</b>	225	14,67 €
	<b>MJG250</b>	250	16,00 €
<b>MJG300</b>	300	21,82 €	



TUBERÍA SHUNT CON TUBO INTERIOR PARA TUBO HELICOIDAL CON JUNTA DE GOMA

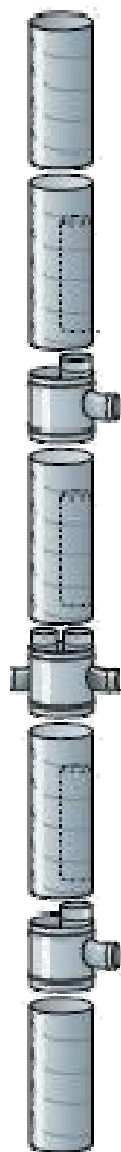

TUBO

Te Shunt con tubo interior y junta de goma

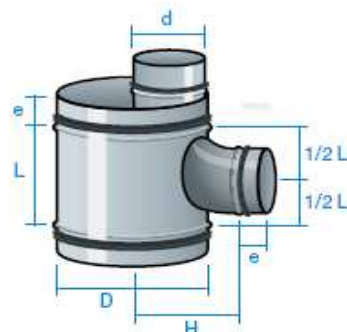

Tramo tubo interior a medida 1 / 1.5 / 2 m

Te Shunt con junta

Tubo helicoidal general con tubo secundario inscrito

Cruz Shunt con codos 90°

Tubo helicoidal general con tubo secundario inscrito

Te Shunt con junta

TUBO

Referencia	Diámetro D	Diámetro d	L	H	Euros
TSTI158	150	80	125	115	29,01 €
TSTI178	175	80	125	125	29,70 €
TSTI171	175	100	145	130	34,83 €
TSTI201	200	100	145	140	35,76 €
TSTI251	250	100	145	165	39,27 €
TSTI202	200	125	170	145	42,59 €
TSTI252	250	125	170	170	46,38 €
TSTI302	300	125	170	195	50,18 €
TSTI352	355	125	170	222	55,72 €
TSTI222	225	150	210	173	53,63 €
TSTI215	250	150	210	186	55,96 €
TSTI281	280	150	210	200	57,25 €
TSTI315	300	150	210	210	58,42 €
TSTI311	315	150	210	218	61,62 €
TSTI351	355	150	210	238	65,01 €

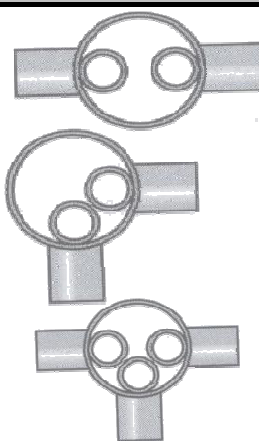
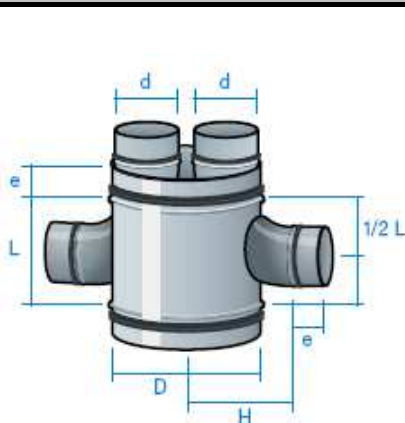

2 INJERTOS A 180°

2 INJERTOS A 90°

3 INJERTOS A 90°

Referencia	Diámetro D	Diámetro d	L	H	Euros	Euros	Euros
TSTI158	250	80	125	115	62,91 €	62,91 €	88,04 €
TSTI178	300	100	145	130	80,24 €	80,24 €	112,36 €
TSTI171	355	125	170	222	89,15 €	89,15 €	124,81 €
TSTI201	400	125	170	245	98,02 €	98,02 €	137,17 €
TSTI251	450	125	170	270	105,66 €	105,66 €	149,62 €
TSTI202	500	125	170	295	118,74 €	118,74 €	166,30 €